

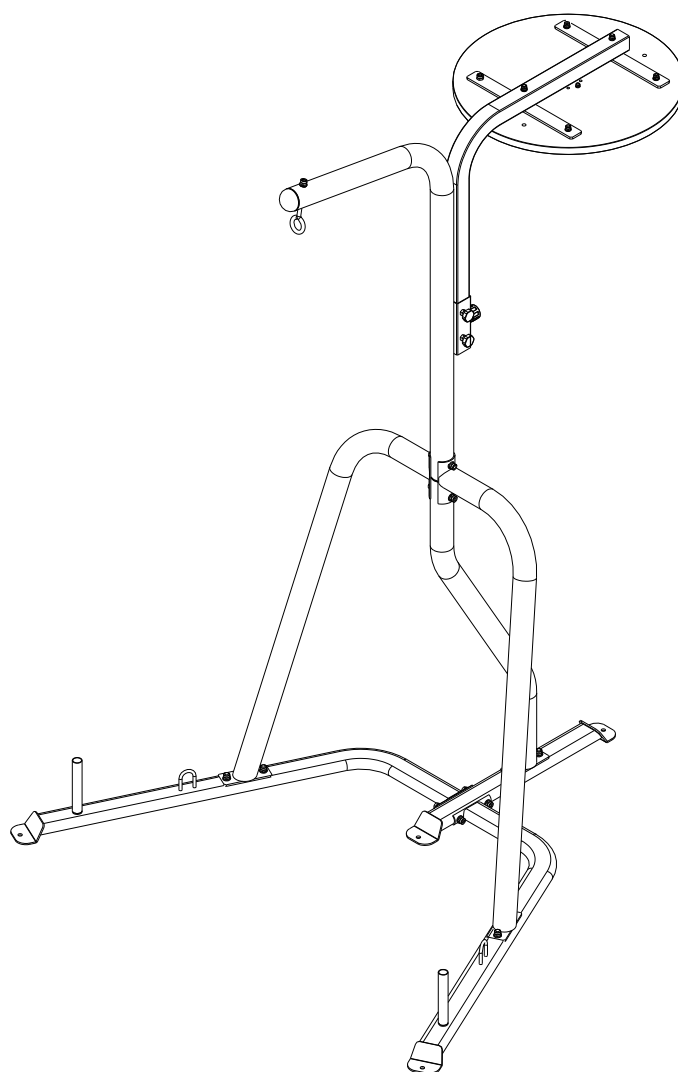

## RINGMASTER RINGSIDE TRAINER 700

FRMRT700



FRMRT7000 OWNER'S MANUAL

# ASSEMBLY MANUAL

## RINGMASTER RINGSIDE TRAINER 700

### BEFORE YOU START

Remove all parts from the packaging and separate and count each various component to ensure everything has been correctly provided.

Follow the instructions and consult both the individual assembly pages and the overall expanded views of the equipment.

Certain parts may arrive pre-assembled from the factory.

It is the owner's responsibility to ensure that all users of this unit have read the owner's manual and are familiar with the safety precautions.

### SAFETY PRECAUTIONS

- Highly recommended for two or more people to assemble the equipment to avoid injury.
- Assemble the equipment on a flat level surface.
- Consider placing a mat under the equipment to protect your floor.
- Wear appropriate footwear and clothing during assembly and use.
- Only tighten nuts and bolts by hand until the whole equipment is assembled
- Ensure you correctly orientate each piece before attaching
- Do not allow children and pets to be unsupervised around the assembly or usage of this equipment.
- Ensure all parts are in full working order before use.
- Only one person should use the machine at any one time.
- Do not use the equipment outdoors or around water.
- Keep hair, fingers or clothing away from moving parts.
- Only use attachments recommended by the manufacturer.
- Never operate if any parts are not functioning correctly.
- Always correctly stretch and warm up before using the equipment.
- **Stop immediately** if you experience any pain, dizziness or nausea. See a doctor at once.

PLEASE NOTE: Descriptions of pieces as LEFT and RIGHT are from the point of view of standing behind the equipment facing towards the front.











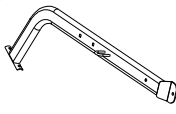
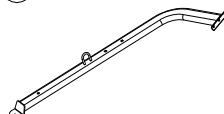
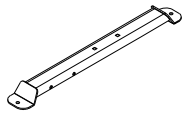
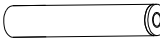
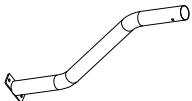
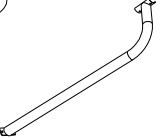
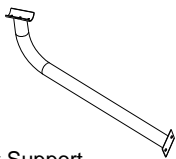
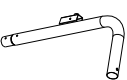
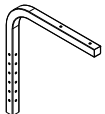
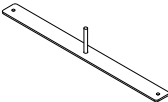





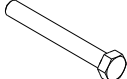
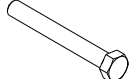

**BEFORE STARTING ANY EXERCISE PROGRAM, CONSULT YOUR DOCTOR. ESPECIALLY IF YOU ARE OVER THE AGE OF 35 OR HAVE PRE-EXISTING HEALTH PROBLEMS.**

**READ ALL INSTRUCTIONS BEFORE ASSEMBLING OR USING ANY FITNESS EQUIPMENT.**

**RINGMASTER ASSUMES NO RESPONSIBILITY FOR PERSONAL INJURY OR PROPERTY DAMAGE SUSTAINED BY OR THROUGH THE USE OF THIS PRODUCT.**

**SAVE THESE INSTRUCTIONS.**

# PARTS LIST

<p>1</p>  <p>Right Base Code: Qty:1</p>	<p>2</p>  <p>Left Base Code: Qty:1</p>	<p>3</p>  <p>Main Base Code: Qty:1</p>	<p>4</p>  <p>Plate Bar Code: Qty:2</p>	<p>5</p>  <p>Main Vertical Support Code: Qty:1</p>
<p>6</p>  <p>Right Support Code: Qty:1</p>	<p>7</p>  <p>Left Support Code: Qty:1</p>	<p>8</p>  <p>Punchbag Support Code: Qty:1</p>	<p>9</p>  <p>Platform Adjustment Code: Qty:1</p>	<p>10</p>  <p>Platform Support Code: Qty:2</p>
<p>11</p>  <p>Punchbag Hook Code: Qty:1</p>	<p>12</p>  <p>M16 Popper Pin Code: Qty:1</p>	<p>13</p>  <p>? 10*20 Pin Code: Qty:2</p>	<p>14</p>  <p>Swivel Code: Qty:1</p>	<p>15</p>  <p>M5*40 Cross Head Bolt Code: Qty:4</p>
<p>16</p>  <p>M8*40 Cross Head Bolt Code: Qty:4</p>	<p>17</p>  <p>M10*45 Carrige Bolt Code: Qty:8</p>	<p>18</p>  <p>M10*80 Bolt Code: Qty: 2</p>	<p>19</p>  <p>M10*90 Bolt Code: Qty: 2</p>	<p>20</p>  <p>M5 Washer Code: Qty:4</p>
<p>21</p>  <p>M8 Washer Code: Qty:6</p>	<p>22</p>  <p>M10 Washer Code: Qty:15</p>	<p>23</p>  <p>Speed Bag Platform Code: Qty:1</p>	<p>24</p>  <p>M5 Lock Nut Code: Qty:4</p>	<p>25</p>  <p>M8 Lock Nut Code: Qty:6</p>
<p>26</p>  <p>M10 Lock Nut Code: Qty:11</p>	<p>27</p>  <p>45*45 Tube Plug Code: Qty:2</p>	<p>28</p>  <p>? 60 Round Tube Plug Code: Qty:1</p>	<p>29</p>  <p>? 25 Round Tube Plug Code: Qty:2</p>	

## Step 1

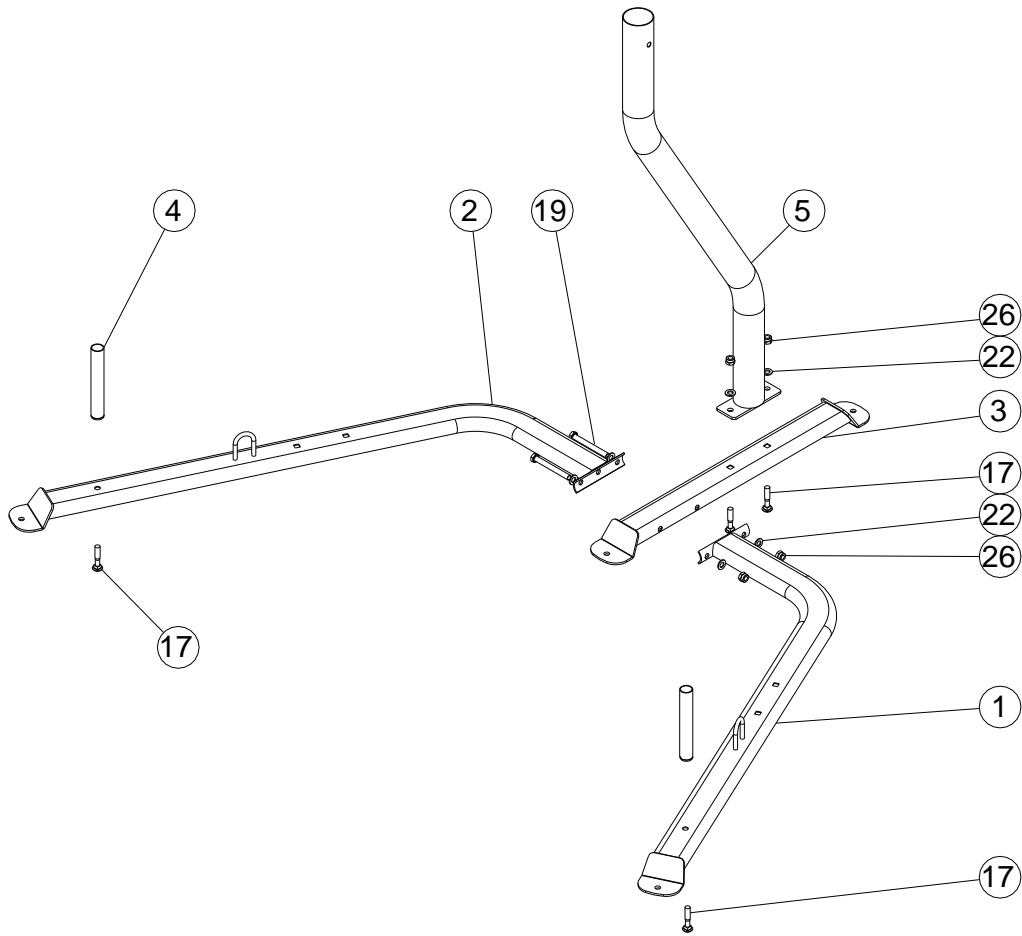

A. Attach Left and Right Base (1, 2) to Main Base (3) with two M10\*90 Bolts (19), four M10 Washers (22) and two M10 Lock Nuts (26).

B. Attach Main Vertical Support (5) to Main Base (3) with two M10\*45 Carrige Bolts (17), two M10 Washers (22) and two M10 Lock Nuts (26).

C. Attach Plate Bar (4) to Left and Right Base (1, 2) with M10\*45 Bolt (17).

## Step 2

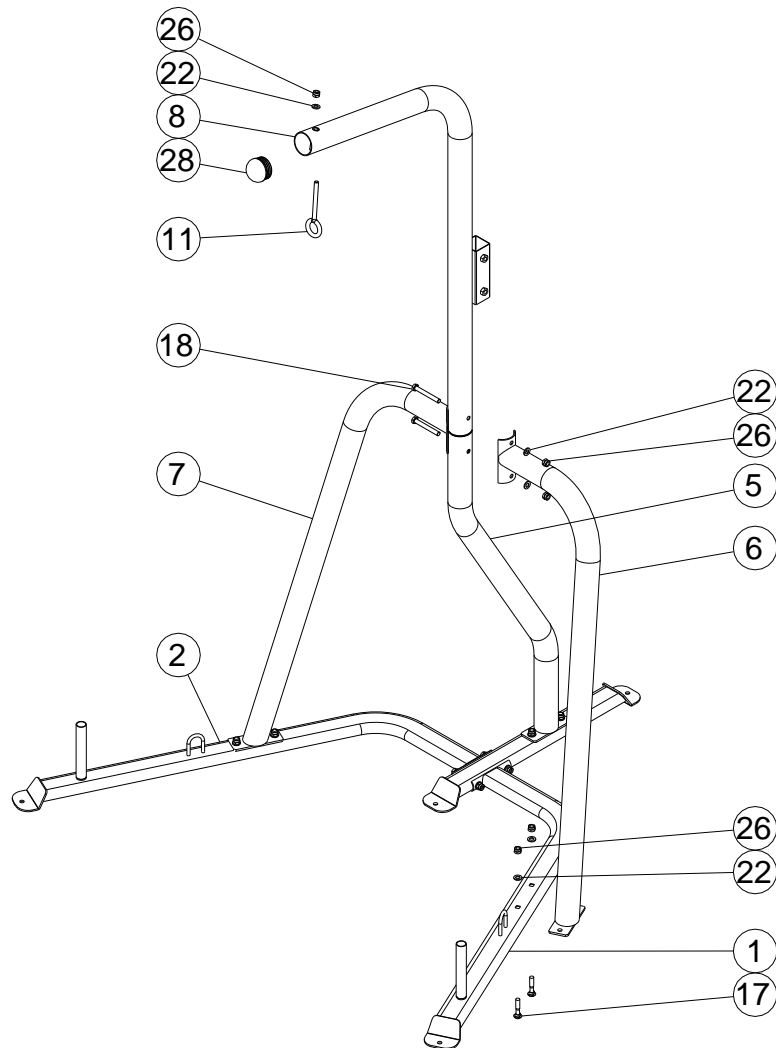

A. Insert Punchbag Support (8) into the top of Main Vertical Support (5), aligning the hole.

B. Attach Left Support (7) and Right Support (6) to Left and Right Base (1, 2) with four M10\*45 Carriage Bolts (17), four M10 Washers (22) and four M10 Lock Nuts (26).

C. Attach Left and Right Support (7, 6) to Main Vertical Support (5) and Punchbag Support (8) with two M10\*80 Bolts (18), four M10 Washers (22) and two M10 Lock Nuts (26).

D. Attach Punchbag Hook (11) to Punchbag Support (8) with M10 Washer (22) and M10 Lock Nut (26).

E. Insert  $\varnothing 60$  Round Tube Plug (28) into Punchbag Support (8).

## Step 3

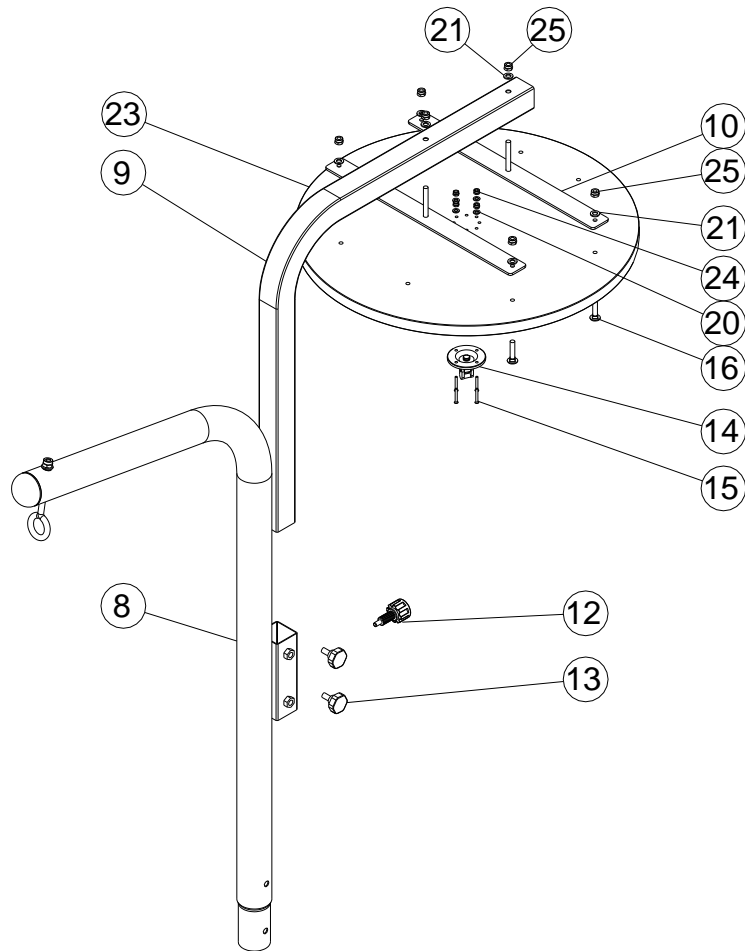

A. Attach Platform Support (10) to Platform Adjustment (9) with two M8 Washers (21) and two M8 Lock Nuts (25).

B. Attach Swivel (14) to Speed bag Platform (23) with four M5\*40 Bolts (15), four M5 Washers (20) and four M5 Lock Nuts (24).

C. Attach Speed ball Platform (23) to Platform Support (10) with four M8\*40 Bolts (16), four M8 Washers (21) and four M8 Lock Nuts (25).

D. Slide the Platform Adjustment (9) into the square tube on the Punchbag Support (8), aligning the hole and secure with M16 Popper Pin (12) and two M10\*20 Pin (13).

# Ringmaster

Est. 1972

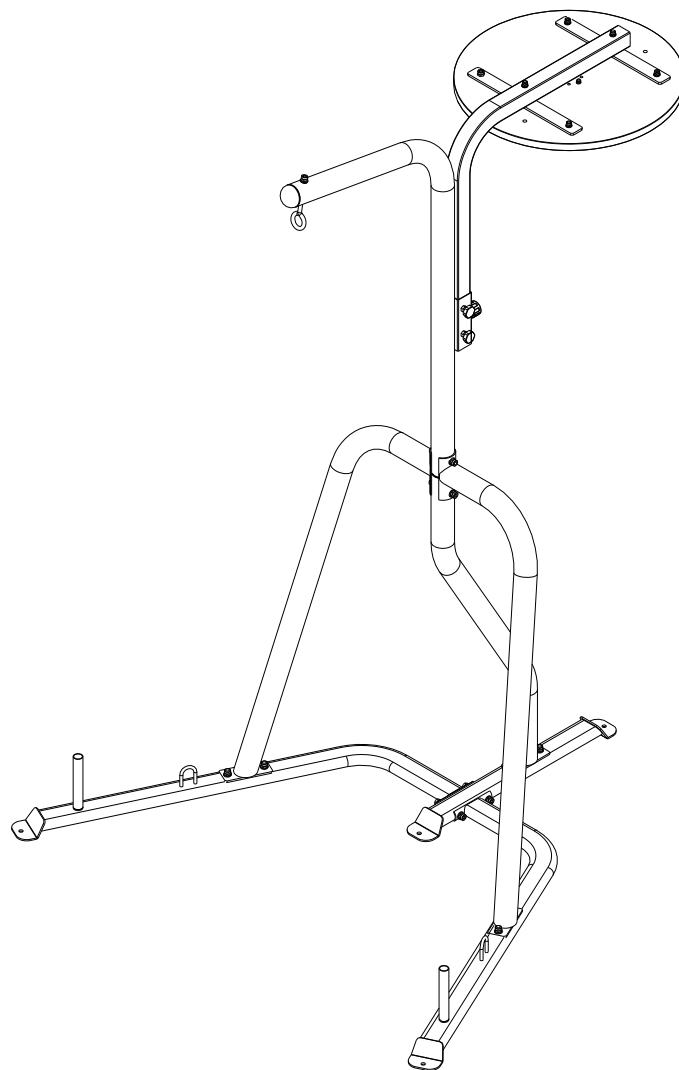

MADE IN CHINA FOR

[WWW.RINGMASTERFITNESS.COM.AU](http://WWW.RINGMASTERFITNESS.COM.AU)