



**E-Jet Sport**

Since 1975

MODEL: EPK017  
NAME: 22FT PORTABLE PICKLEBALL NET  
- HOME USE

# ASSEMBLY INSTRUCTIONS

---



## ASSEMBLY TIPS:

- 1 - Please read the instructions carefully, and follow all assembly, operation or safety instructions properly in order to avoid damage or injury.
- 2 - Some figures or drawings may not look exactly like your product. Please read and understand the text before beginning each assembly step.

## NOTICE!

- 1 - Check all contents are included before assembly.
- 2 - Always assemble and disassemble the product under adult supervision.
- 3 - Check the equipment each Time before use.
- 4 - Any breakage found on the product, please stop assembling or disassembling it.




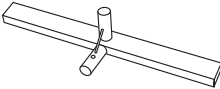



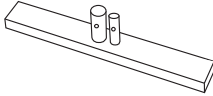

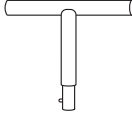
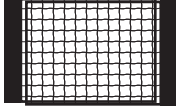

**WARNING:** Adult Assembly Required.



**WARNING:**









CHOKING HAZARD -- This item contains small parts. Not suitable for children under 3 years.

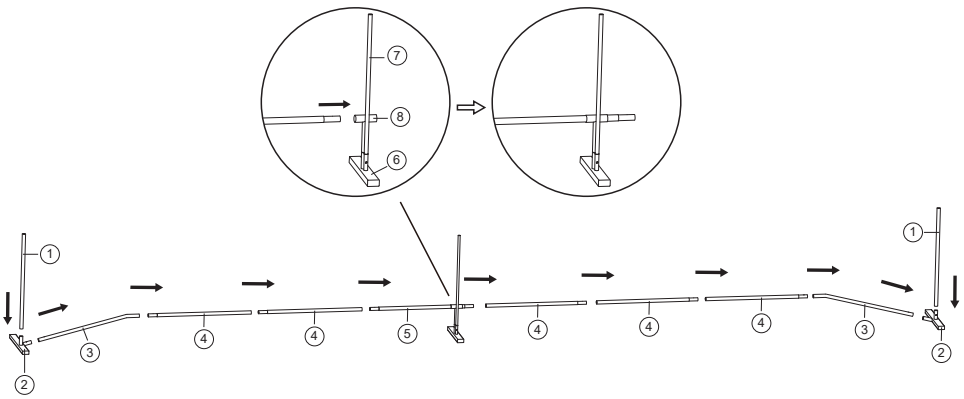
# PARTS LIST

<p><b>1</b> For FIG. 1</p>  <p>Straight pipe with end cap (2pcs)</p>	<p><b>2</b> For FIG. 1</p>  <p>End base (2pcs)</p>	<p><b>3</b> For FIG. 1</p>  <p>Bent long game (2pcs)</p>
<p><b>4</b> For FIG. 1</p>  <p>Straight pipe(one end tapered) (5pcs)</p>	<p><b>5</b> For FIG. 1</p>  <p>Straight pipe(both ends tapered) (1pc)</p>	<p><b>6</b> For FIG. 1</p>  <p>Center base (1pc)</p>
<p><b>7</b> For FIG. 1</p>  <p>Straight narrow pipe (1pc)</p>	<p><b>8</b> For FIG. 1</p>  <p>T-shape center support (1pc)</p>	<p><b>9</b> For FIG. 2</p>  <p>Net (1pc)</p>
<p><b>10</b></p>  <p>Carry bag (1pc)</p>		


# ASSEMBLY INSTRUCTIONS

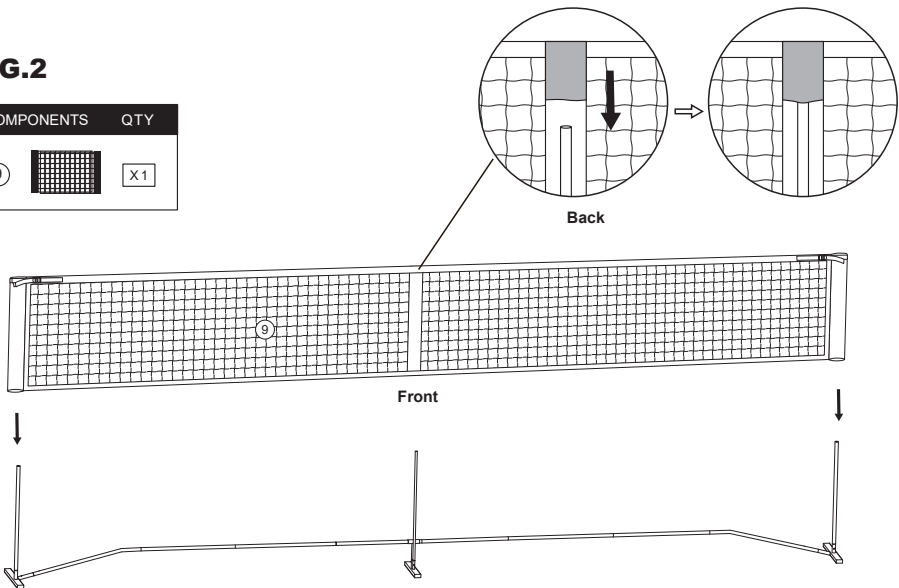
**FIG.1**

COMPONENTS	QTY	COMPONENTS	QTY	COMPONENTS	QTY	COMPONENTS	QTY
	X2		X2		X1		X1
	X2		X5		X1		X1

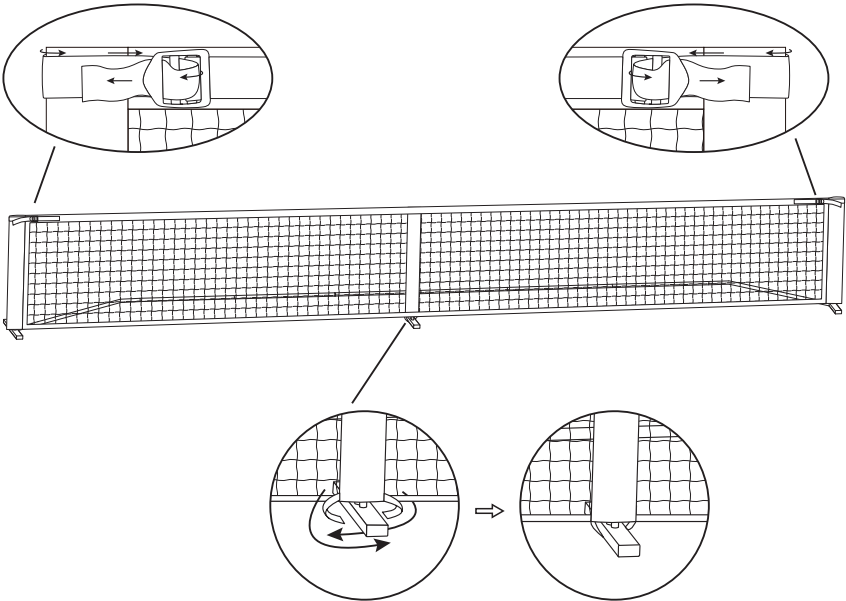


**FIG.2**

COMPONENTS	QTY
	X1



**FIG.3**



**YOU ARE NOW READY TO PLAY!**